

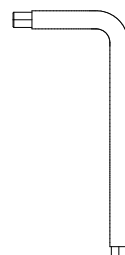

F-342201L



a



x n°1

- I Prima di iniziare il montaggio, identificare tutti i componenti con l'aiuto delle istruzioni.
- GB Before starting to assembly, please identify all components.
- D Vor der Montage, sind die Einzelteile anhand der Montageanleitung zu identifizieren.
- F Avant de débuter le montage, identifiez tous les composants à l'aide de la notice.
- E Antes de iniciar el montaje, identifique todos los componentes con ayuda de la nota.

F-342201LA



b

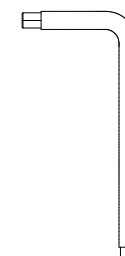

x n°1

c

- I Pezzo di ricambio.
- GB Spare part.
- D Ersatzteil.
- F Pièce en échange / s.a.v.
- E Repuesto

H-A 3422 01 00

calligaris

ASSOCIATO A
FLA
 ASSARREDDO
 ASSOCIAZIONE FEDERLEGGIARRREDDO

ISO
 9001:2015

Calligaris S.p.A.
 Via Trieste, 12
 33044 Manzano
 (Udine) Italy
 Tel. +39 0432 748211
 calligaris.com

Copyright © Calligaris S.p.a. Tutti i diritti riservati - All right reserved

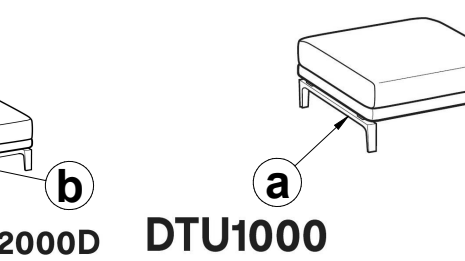
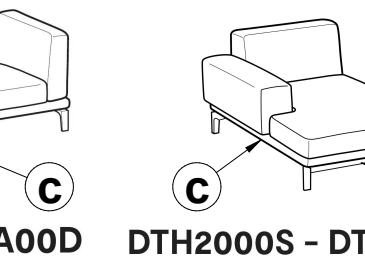
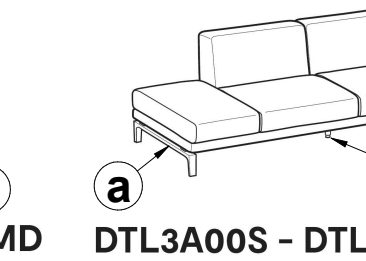
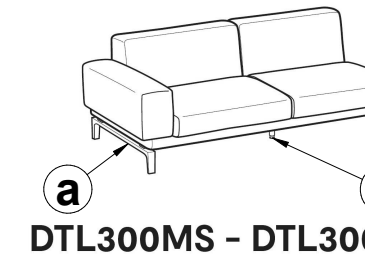
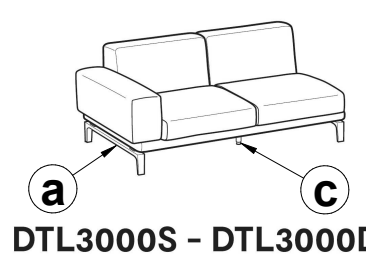
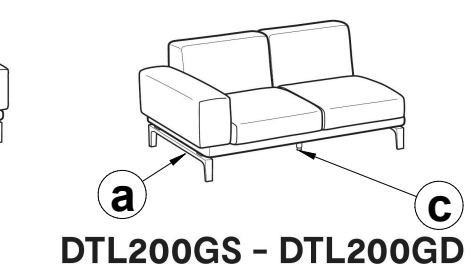
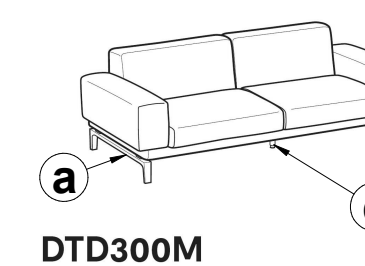
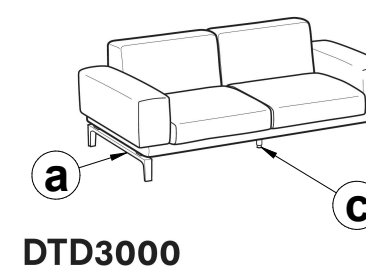
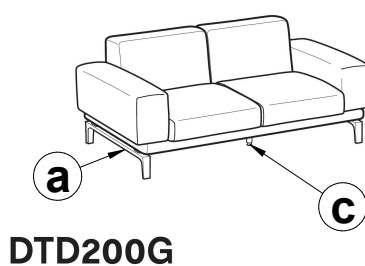
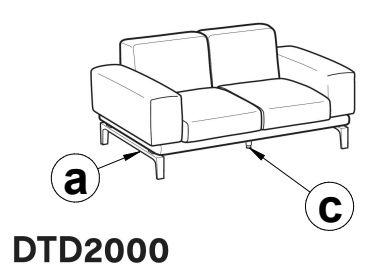
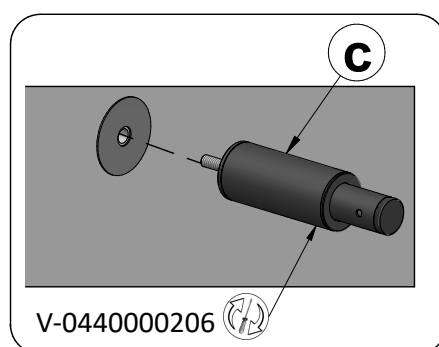
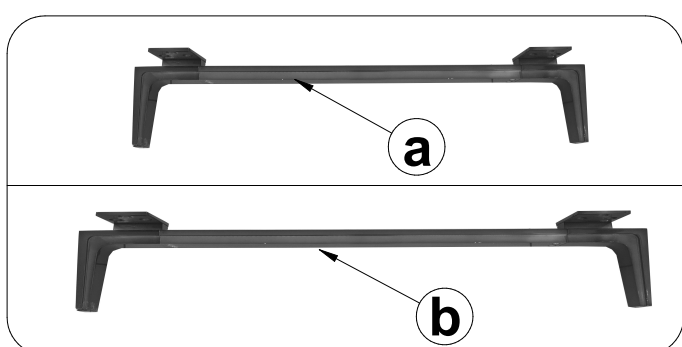
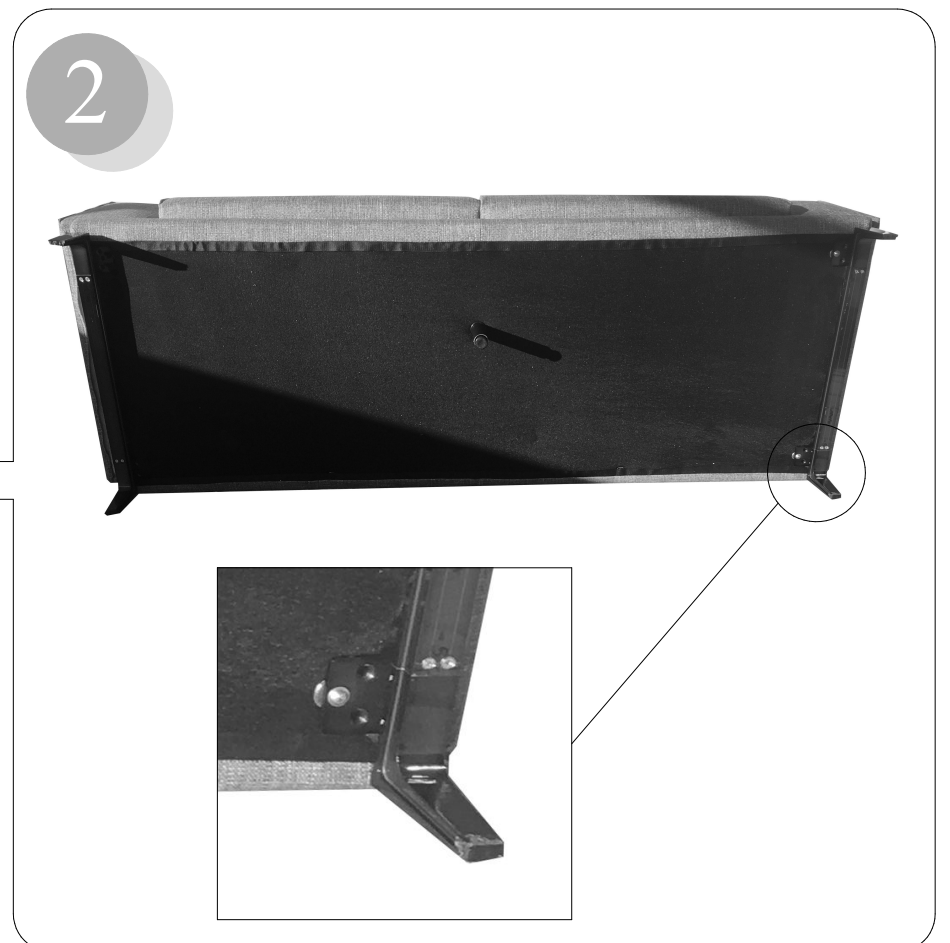
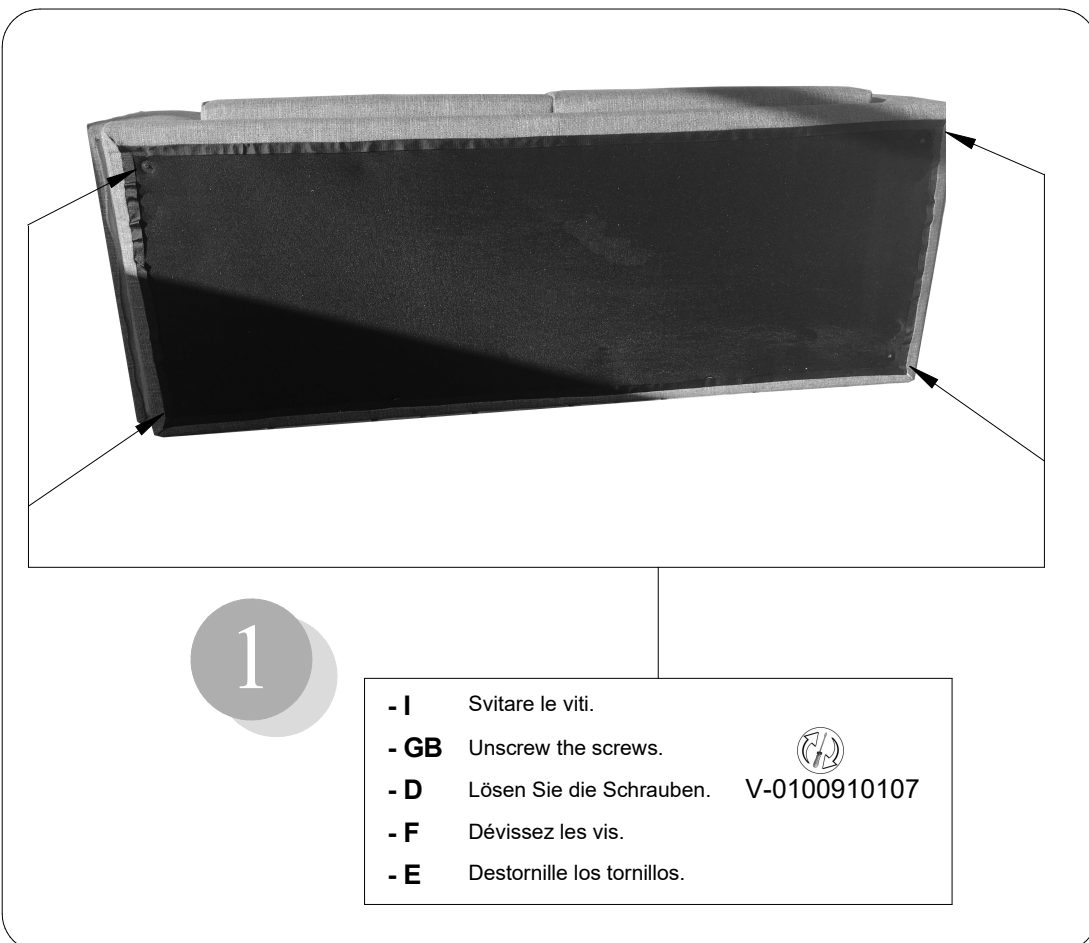
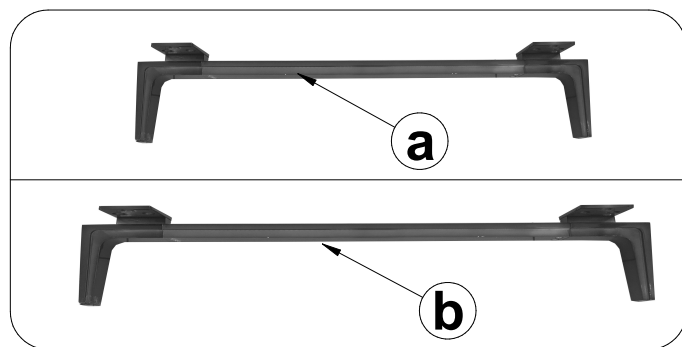

Copyright © Calligaris S.p.a. Tutti i diritti riservati - All right reserved

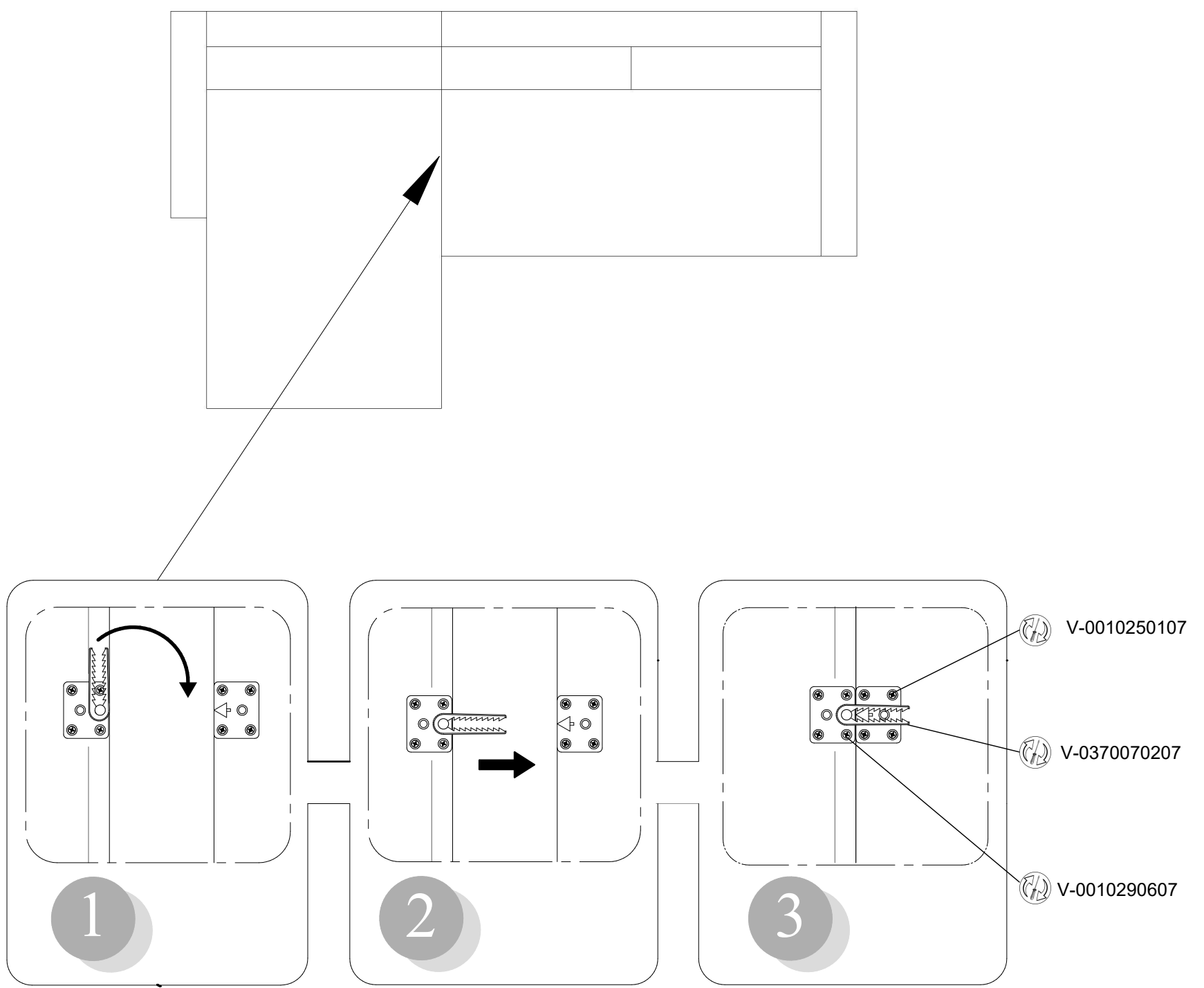

Attenzione-Attention-Vorsicht-Attention-Atención

- **I** Per sfoderare seguire le seguenti indicazioni.
- **GB** Please follow the instructions to remove the cover
- **D** Beim abziehen des Bezugs, bitte folgende Anweisungen beachten
- **F** Pour enlever la housse veuillez suivre les indications suivantes
- **E** Para desenfundar seguir las siguientes instrucciones

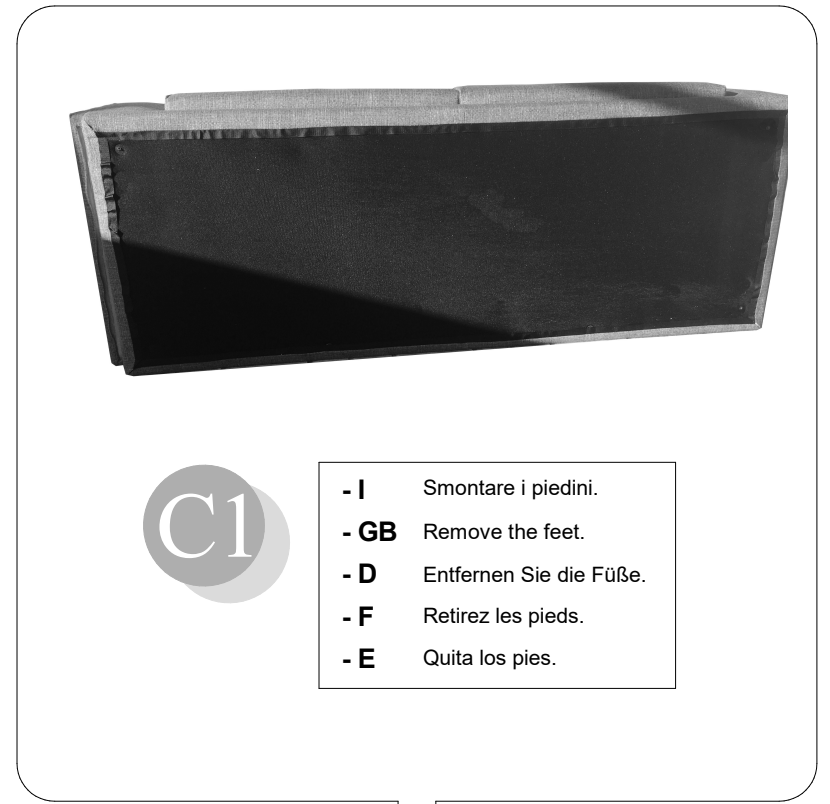
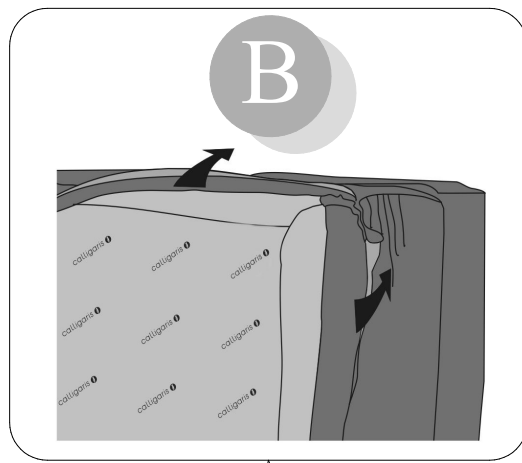
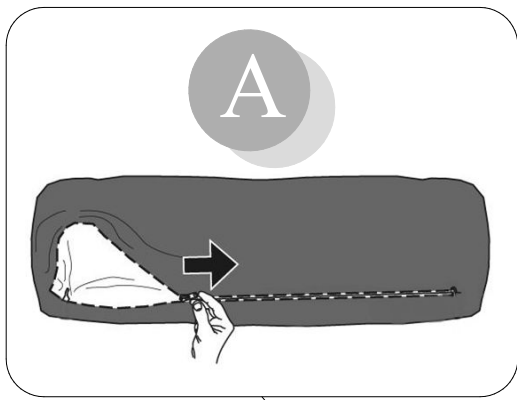

- **I** Smontare i piedini.
- **GB** Remove the feet.
- **D** Entfernen Sie die FüÙe.
- **F** Retirez les pieds.
- **E** Quita los pies.

